

# R1966 SERIES ROCKER SWITCH

ANTI-VANDAL SWITCHES  
DETECTOR SWITCHES  
DIP SWITCHES  
KEYLOCK SWITCHES  
NAVIGATION SWITCHES  
PUSHBUTTON SWITCHES  
ROCKER SWITCHES  
ROTARY SWITCHES  
SLIDE SWITCHES  
SNAP ACTION SWITCHES  
TACTILE SWITCHES  
TOGGLE SWITCHES  
CAP OPTIONS

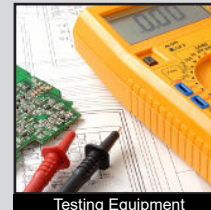

## APPLICATIONS / MARKETS

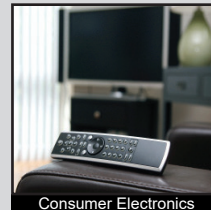
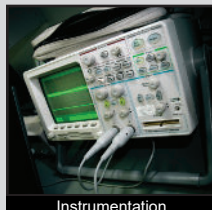
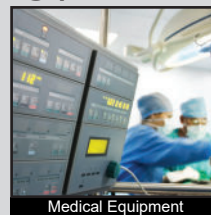
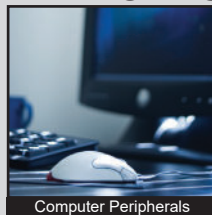

**RoHS**

## SPECIFICATIONS

**Contact Rating:** 15A @ 125VAC UR, cUR

8A @ 250VAC UR, cUR

**Contact Arrangement:** SPST, SPDT

**Electrical Life:** 10,000 cycles

**Mechanical Life:** 30,000 cycles

**Insulation Resistance:** >1000 MΩ

**Dielectric Strength:** 1,500VAC for 1 minute

**Operating Temperature:** -30°C to 65°C

**Storage Temperature:** -30°C to 80°C

**Panel Thickness:** 0.7mm to 3.0mm

## FEATURES & BENEFITS

- Agency approvals: cURus
- SPST and SPDT
- LED Illumination options
- Multiple circuit functions
- Multiple termination options
- Actuator marking available

## PART NUMBER CONFIGURATOR

Series	Circuit	Housing Color	Actuator Color	Marking (see chart)	Termination	LED Color*
<input type="text" value="R"/> <input type="text" value="1"/> <input type="text" value="9"/> <input type="text" value="6"/> <input type="text" value="6"/>	<input type="text" value="A"/>	<input type="text" value="BLK"/> <input type="text" value="WHT"/> <input type="text" value="GRY"/>	<input type="text" value="BLK"/> <input type="text" value="RED"/> <input type="text" value="WHT"/>	<input type="text" value="A"/> <input type="text" value="B"/> <input type="text" value="C"/> <input type="text" value="D"/> <input type="text" value="E"/> <input type="text" value="F"/> <input type="text" value="G"/> <input type="text" value="H"/> <input type="text" value="I"/>	<input type="text" value="F"/> <input type="text" value="S"/> <input type="text" value="R"/> <input type="text" value="L"/>	<input type="text" value="RED"/> <input type="text" value="GRN"/> <input type="text" value="BLU"/> <input type="text" value="YEL"/>
<b>R1966</b>	A - SPST, On-Off C - SPDT, On-On D - SPDT, On-Off-On E - SPST, On-(Off) F - SPST, Off-(On) G - SPDT, On-(On) H - SPDT, On-Off-(On) I - SPDT, (On)-Off-(On)	<b>BLK</b> - Black <b>WHT</b> - White <b>GRY</b> - Grey	<b>BLK</b> - Black <b>RED</b> - Red <b>WHT</b> - White		F - 0.187 QC .031 thk G - 0.187 QC .020 thk S - Solder Lug P - PCB Pins R - Right Angle PCB Pins L - Left Angle PCB Pins	<b>RED</b> - Red <b>GRN</b> - Green <b>BLU</b> - Blue <b>YEL</b> - Yellow

**NOTES:**

\* LED Color option only available with the "A" circuit option

From the "A" circuit option with either the "R" or "L" terminal option, the LED terminals are solder lug terminals and are not bent in either the right or left angle terminal direction as the switch terminals. They protrude straight out from the switch body.

Specifications subject to change without notice 4.26.2023



**E-SWITCH®**

www.e-switch.com

800.867.2717

1

# R1966 SERIES ROCKER SWITCH

## BODY DIMENSIONS ILLUMINATED

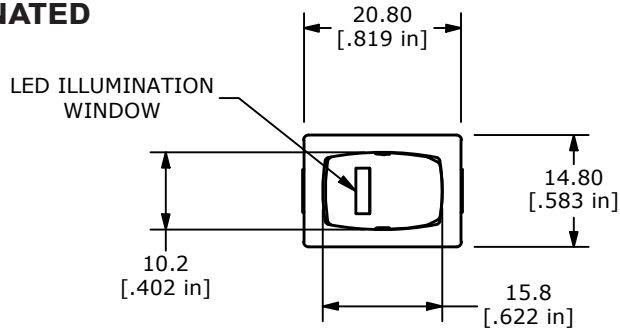

WHEN LED IS USED WITH TRMINALS	DIM "Y"
F, G, P, L, R	6.1 (0.24)
S	1.7 (0.07)

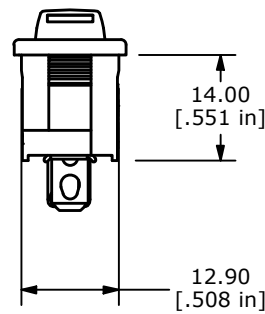
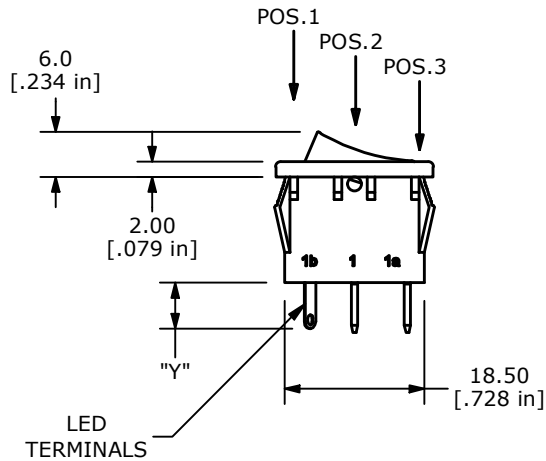

## BODY DIMENSIONS NON ILLUMINATED

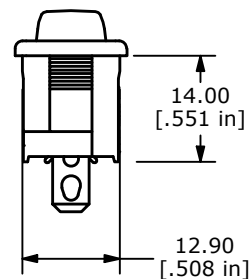
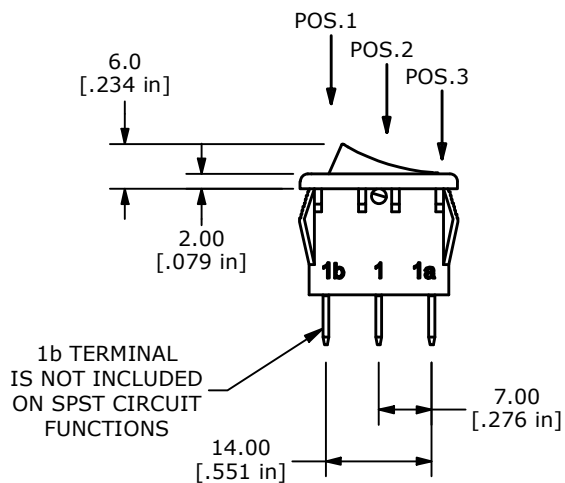
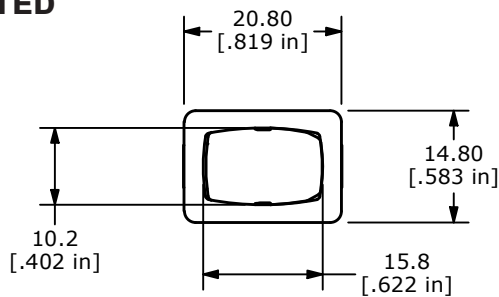

# R1966 SERIES ROCKER SWITCH

## TERMINATION OPTIONS

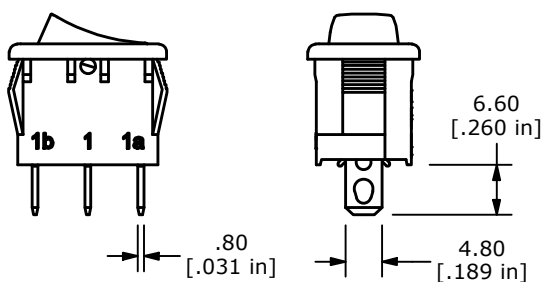

"F" TERMINAL

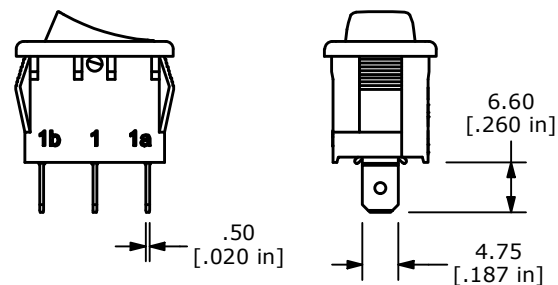

"G" TERMINAL

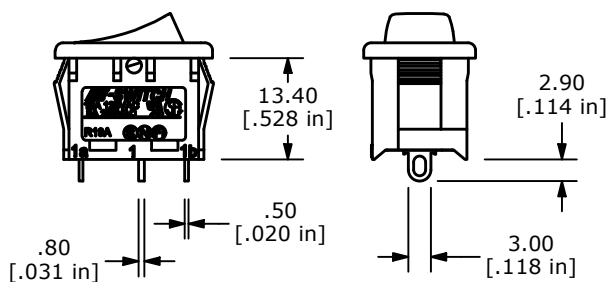

"S" TERMINAL

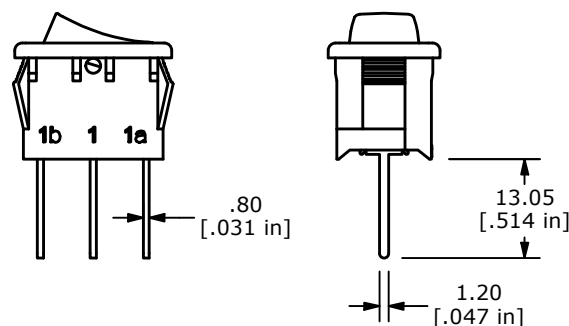

"P" TERMINAL

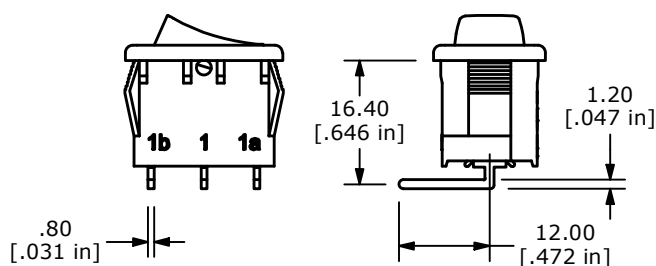

"L" TERMINAL  
(LEFT ANGLE)  
(TERMINALS BENT AWAY FROM LOGO SIDE)

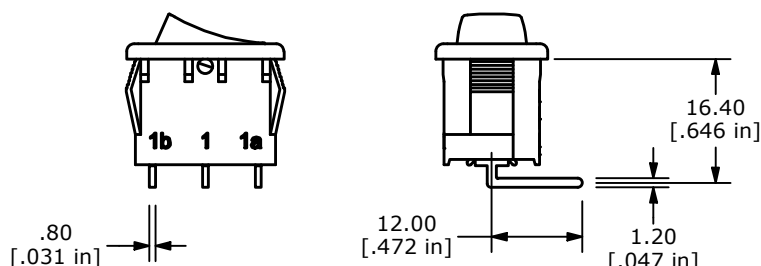

"R" TERMINAL  
(RIGHT ANGLE)  
(TERMINALS BENT TOWARDS THE LOGO SIDE)

## FUNCTION CHART

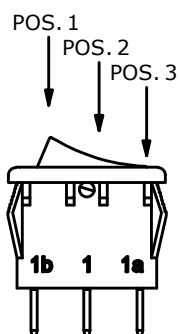

R1966 - SINGLE POLE TERMINAL CHART				
VERSION	FUNCTION OPTION	POS. 1	POS. 2	POS. 3
SPST	A - 1 POLE	ON	NONE	OFF
SPDT	C - 1 POLE	ON	NONE	ON
SPDT	D - 1 POLE	ON	OFF	ON
SPST	E - 1 POLE	ON	NONE	(OFF)
SPST	F - 1 POLE	OFF	NONE	(ON)
SPDT	G - 1 POLE	ON	NONE	(ON)
SPDT	H - 1 POLE	ON	OFF	(ON)
SPDT	I - 1 POLE	(ON)	OFF	(ON)
SPST	TERMINAL CLOSURE	1a-1	OPEN	N/A
SPDT	TERMINAL CLOSURE	1a-1	OPEN	1-1b

( ) DENOTES = MOMENTARY



# R1966 SERIES ROCKER SWITCH

## MARKING OPTIONS

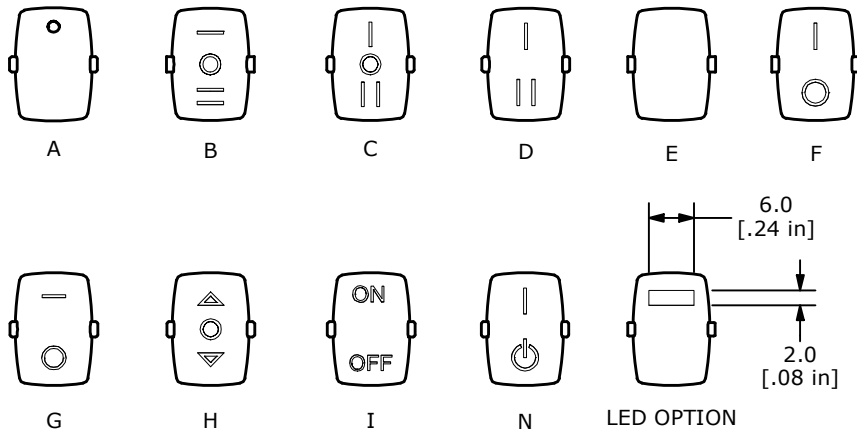

## SCHEMATICS & LAYOUTS

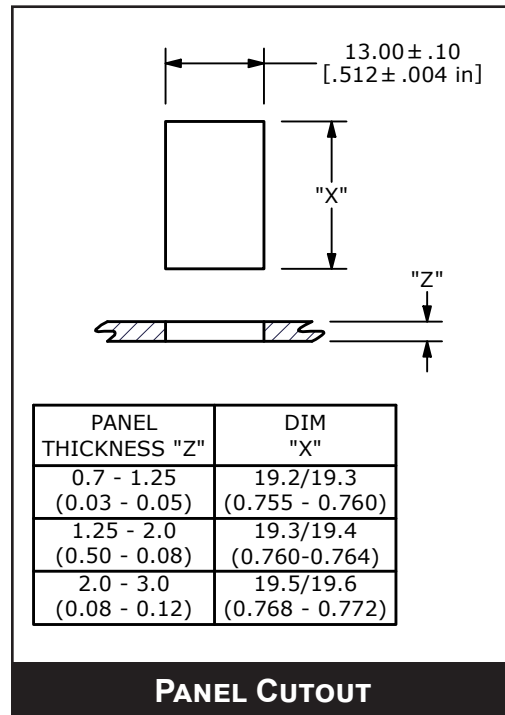
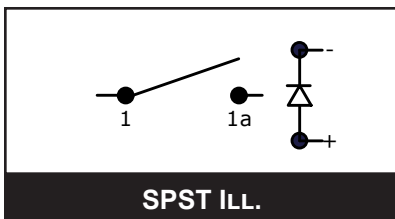
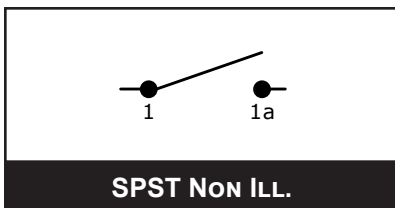
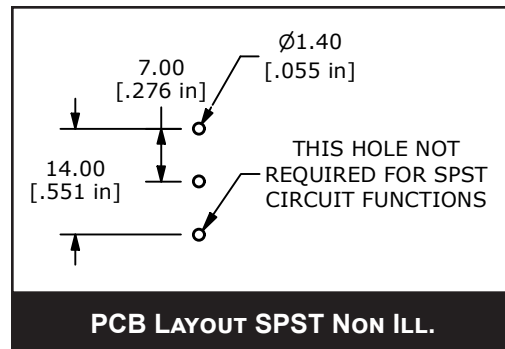
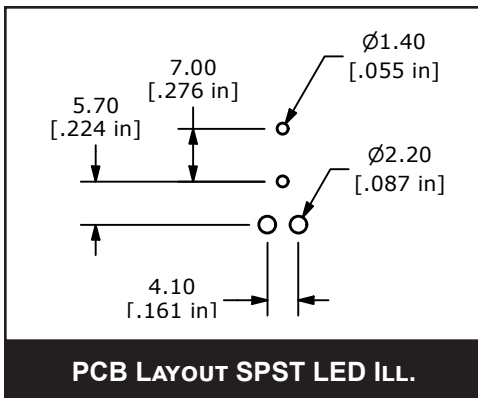

ANTI-VANDAL SWITCHES  
 DETECTOR SWITCHES  
 DIP SWITCHES  
 KEYLOCK SWITCHES  
 NAVIGATION SWITCHES  
 PUSHBUTTON SWITCHES  
**ROCKER SWITCHES**  
 ROTARY SWITCHES  
 SLIDE SWITCHES  
 SNAP ACTION SWITCHES  
 TACTILE SWITCHES  
 TOGGLE SWITCHES  
 CAP OPTIONS